

7-3-2024

LENZA - 63 x 117 FIREPLACE - RIGHT ACCESS DOOR DESIGN

ROBERT LUNDELL  
KEYSTONE RETAINING WALL SYSTEMS LLC

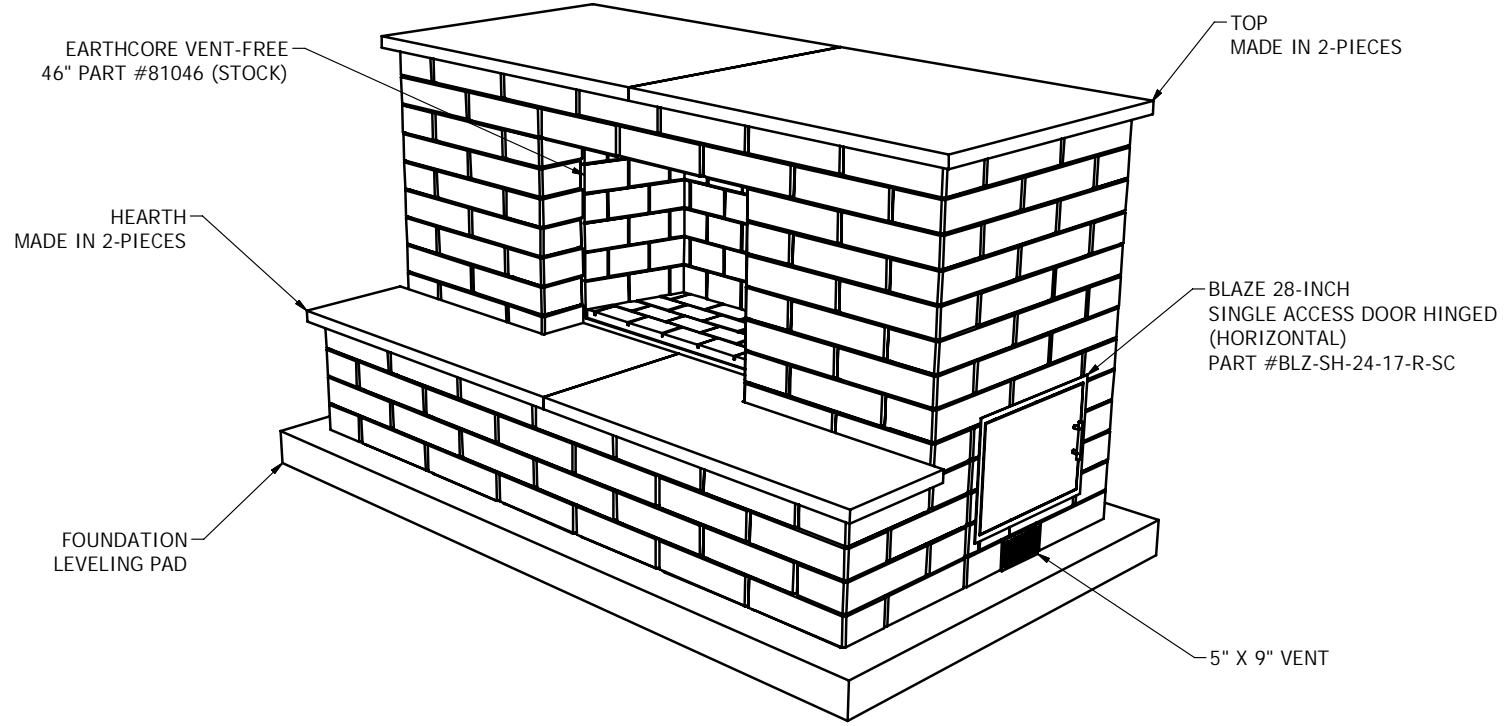

ISOMETRIC VIEW

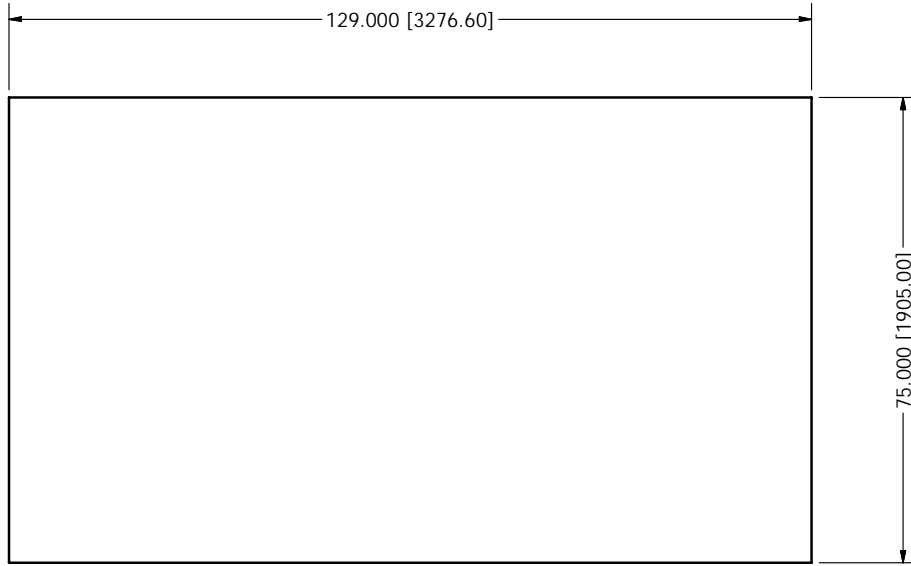

PLAN VIEW

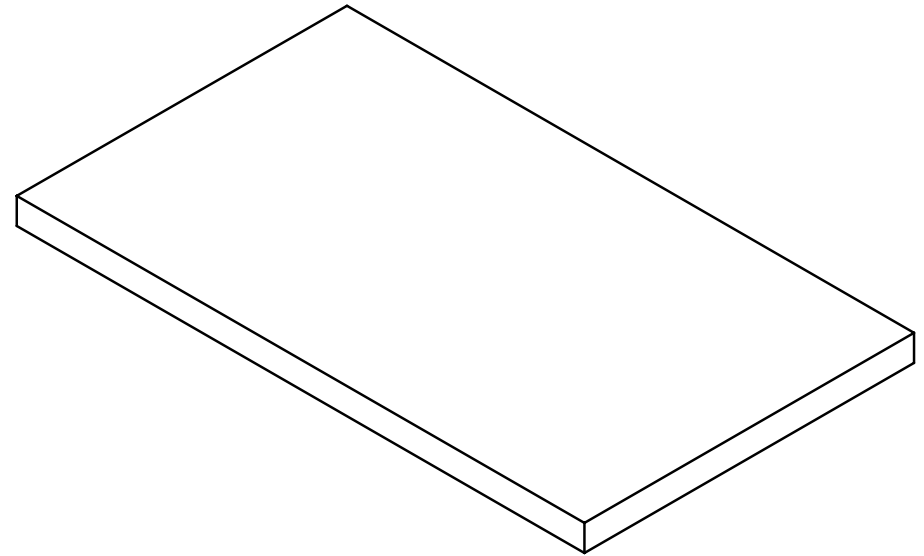

ISOMETRIC VIEW

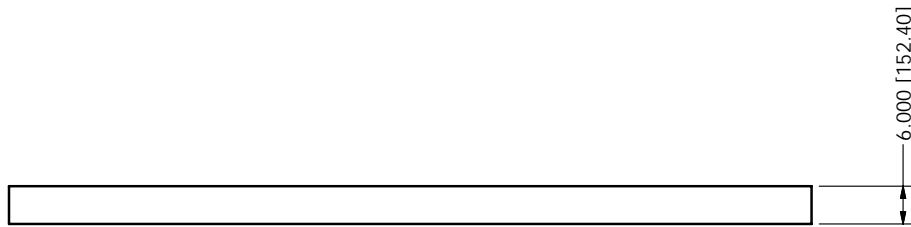

FRONT ELEVATION VIEW



SIDE ELEVATION VIEW

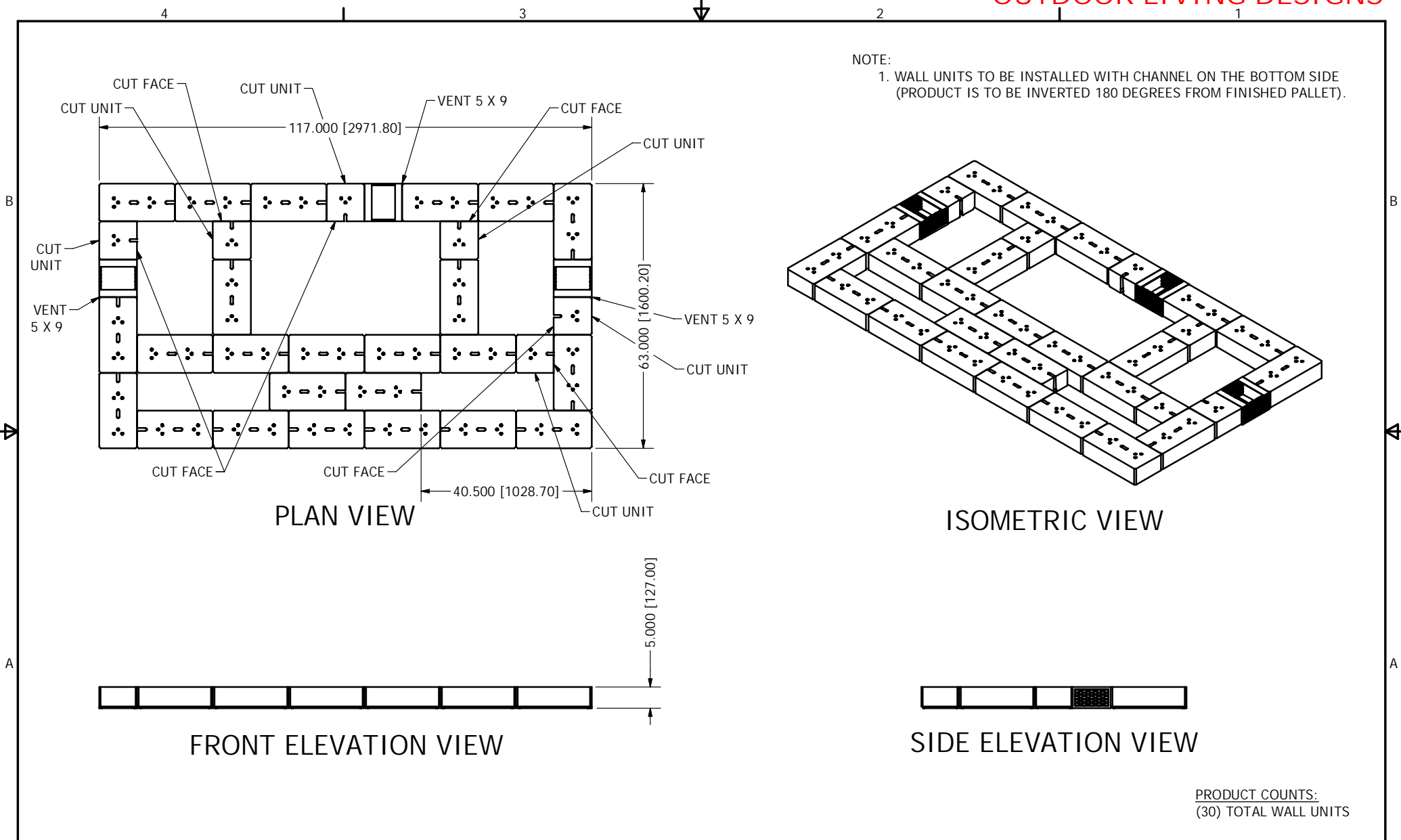

PRODUCT COUNTS:  
 (30) TOTAL WALL UNITS

# OUTDOOR LIVING DESIGNS

NOTE:

1. WALL UNITS TO BE INSTALLED WITH CHANNEL ON THE BOTTOM SIDE (PRODUCT IS TO BE INVERTED 180 DEGREES FROM FINISHED PALLET).

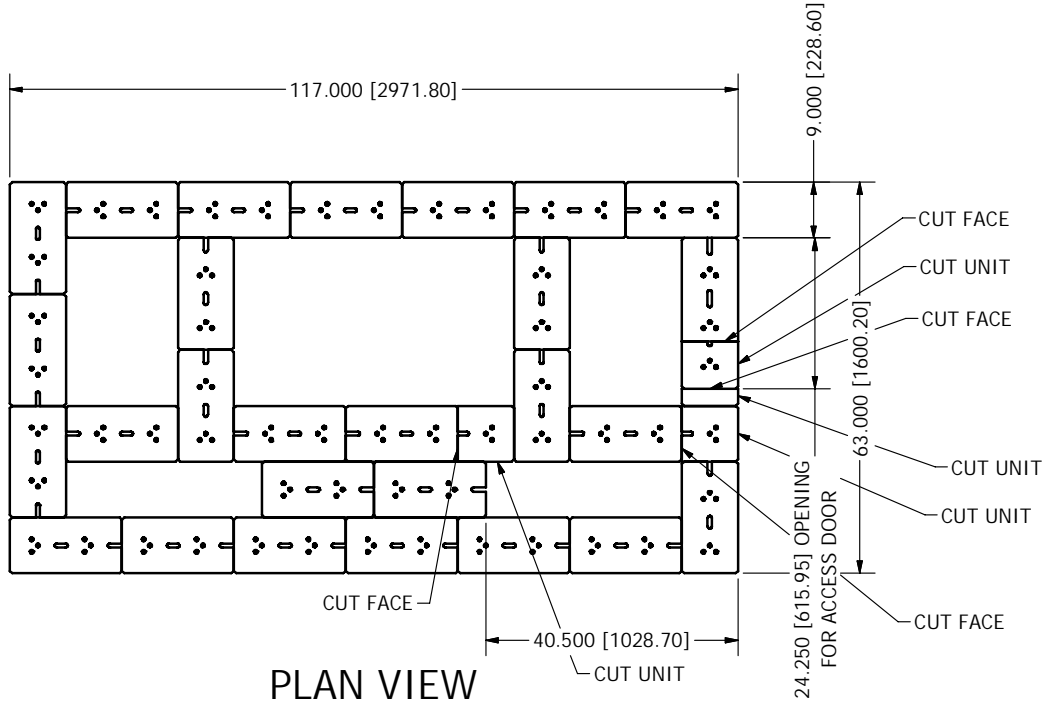

PLAN VIEW

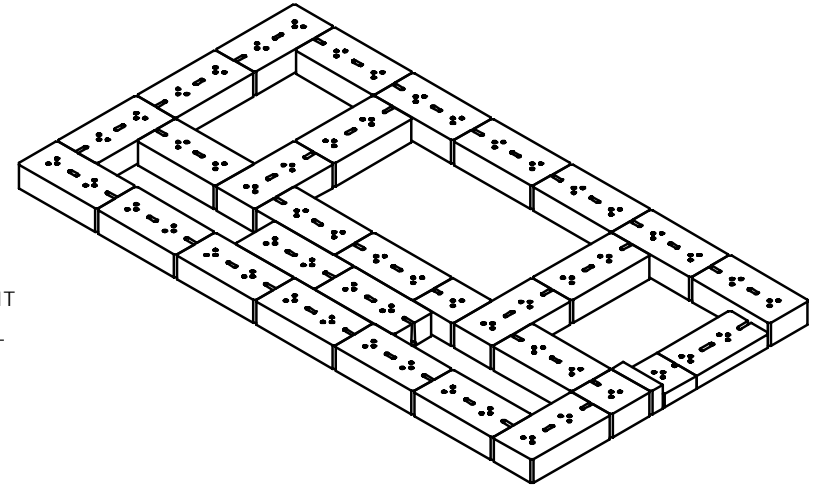

ISOMETRIC VIEW

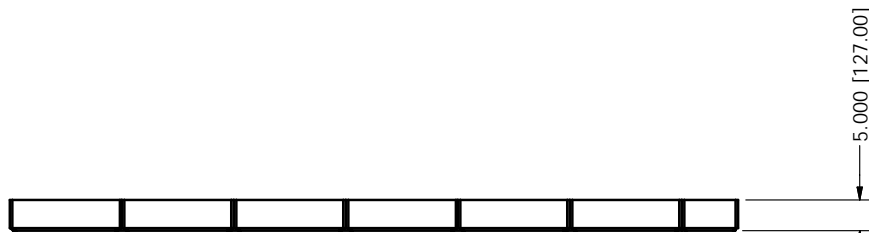

FRONT ELEVATION VIEW

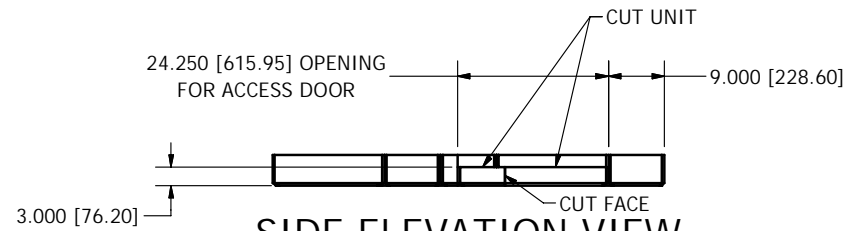

SIDE ELEVATION VIEW

PRODUCT COUNTS:  
(31) TOTAL WALL UNITS

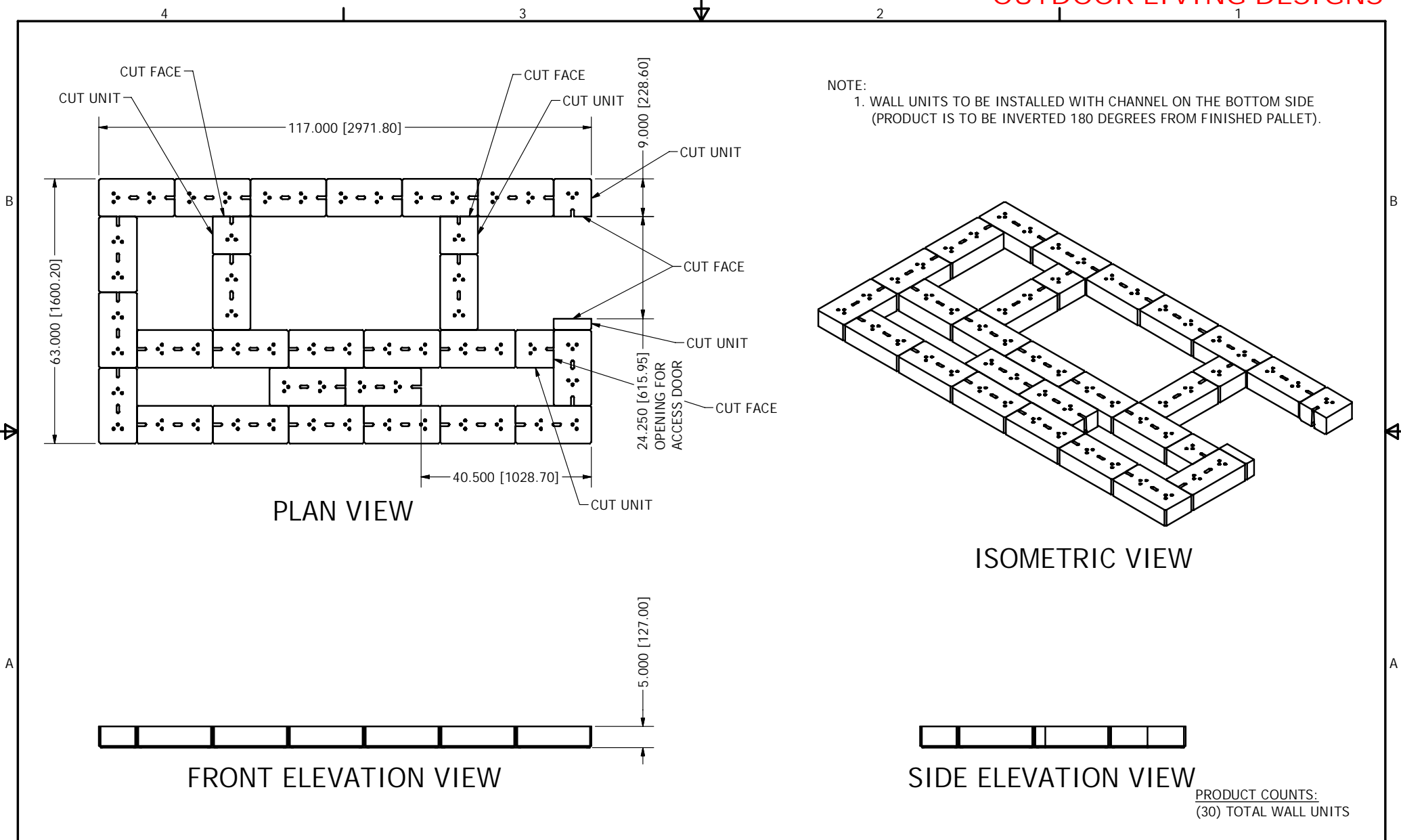

NOTE:  
1. WALL UNITS TO BE INSTALLED WITH CHANNEL ON THE BOTTOM SIDE (PRODUCT IS TO BE INVERTED 180 DEGREES FROM FINISHED PALLET).

PLAN VIEW

ISOMETRIC VIEW

FRONT ELEVATION VIEW

SIDE ELEVATION VIEW

PRODUCT COUNTS:  
(30) TOTAL WALL UNITS

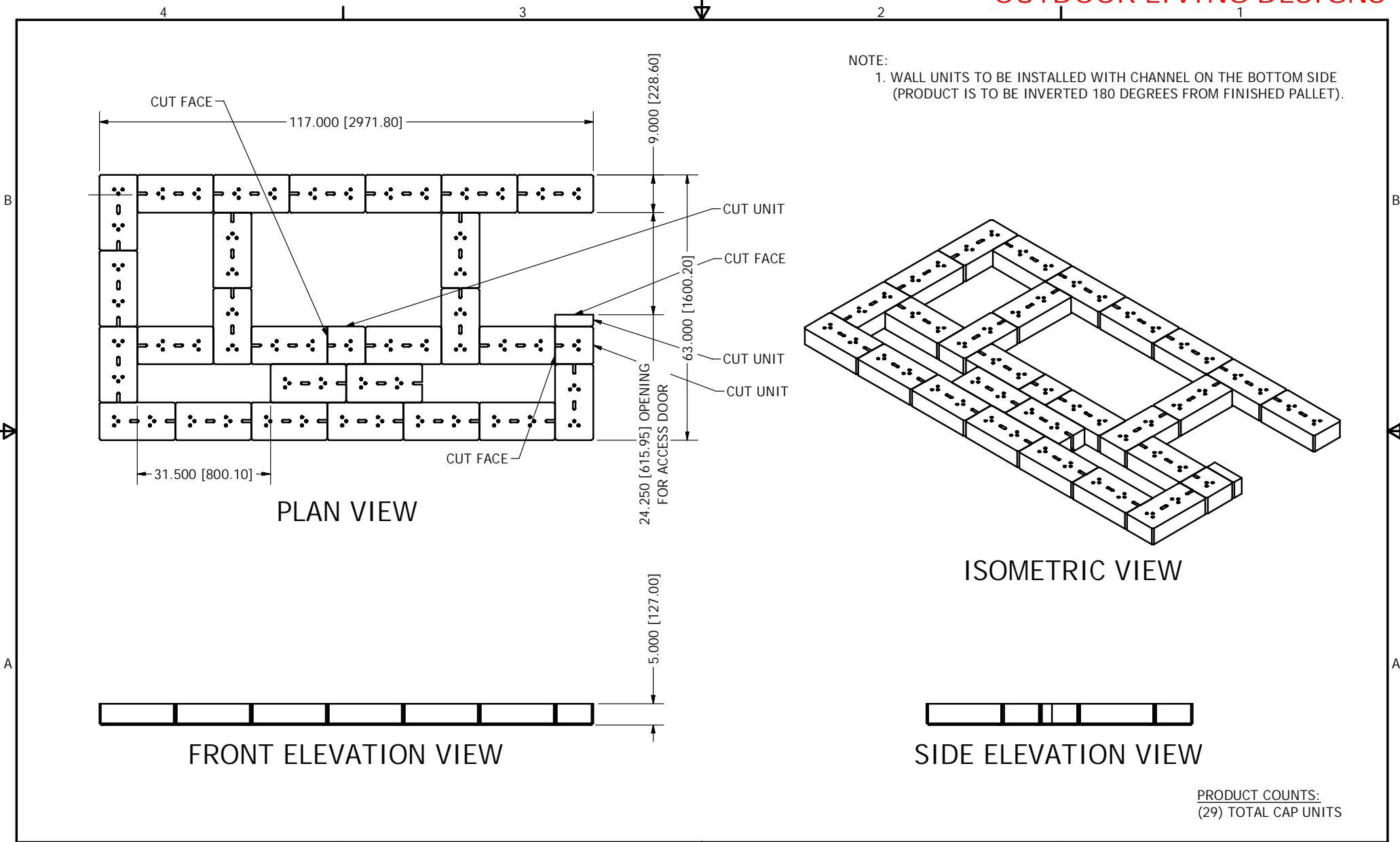

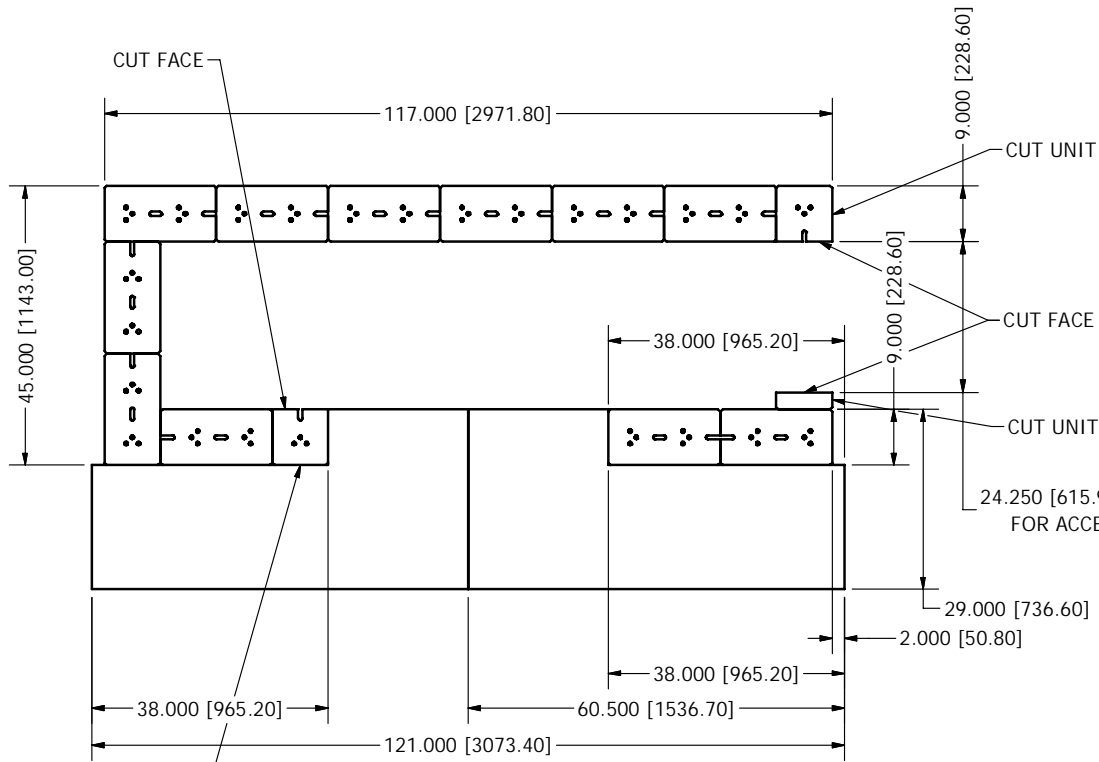

PLAN VIEW

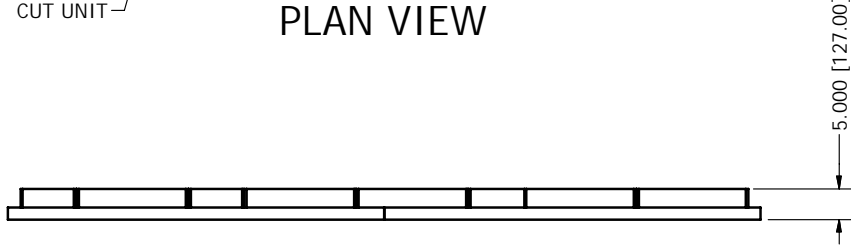

FRONT ELEVATION VIEW

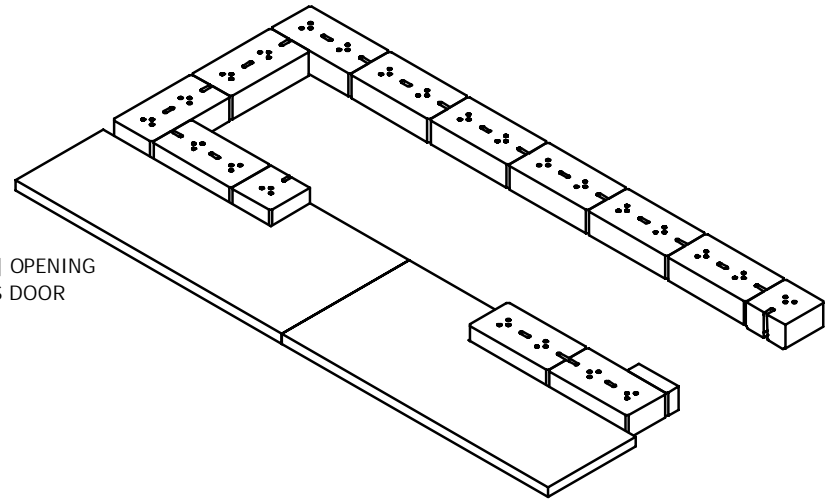

ISOMETRIC VIEW

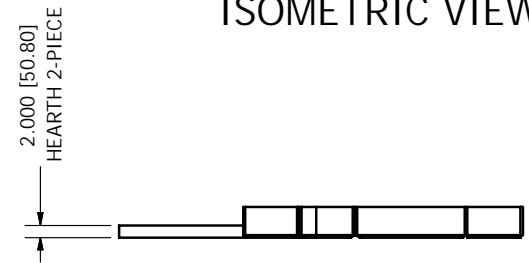

SIDE ELEVATION VIEW

- NOTE:
1. WALL UNITS TO BE INSTALLED WITH CHANNEL ON THE BOTTOM SIDE (PRODUCT IS TO BE INVERTED 180 DEGREES FROM FINISHED PALLET).
  2. HEARTH PIECE IS TO BE MADE FROM THE SAME MATERIAL AS THE COUNTER TOP, (2" ± THICK).
  3. UNLESS OTHERWISE DIRECTED INSTALL AND SECURE HEARTH PIECES WITH APPROVED ADHESIVE OR BONDING AGENT.

PRODUCT COUNTS:  
(14) TOTAL CAP UNITS



NOTE:  
1. WALL UNITS TO BE INSTALLED WITH CHANNEL ON THE BOTTOM SIDE  
(PRODUCT IS TO BE INVERTED 180 DEGREES FROM FINISHED PALLET).

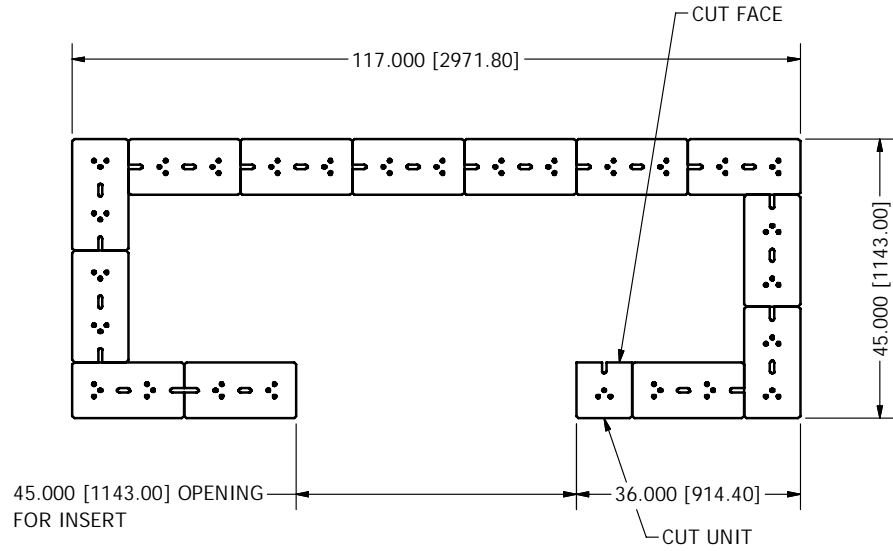

PLAN VIEW

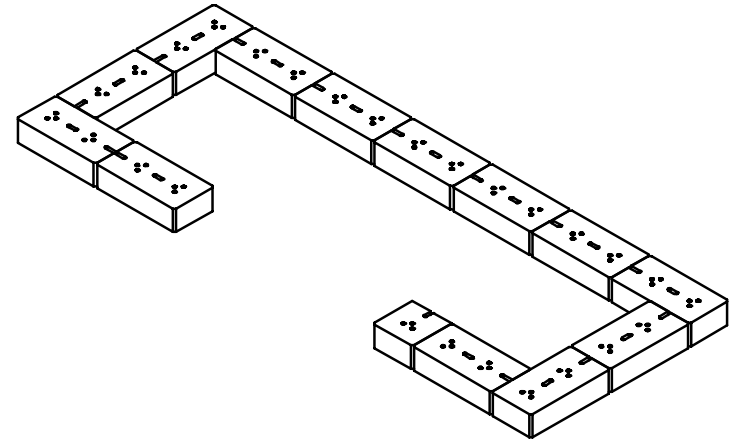

ISOMETRIC VIEW

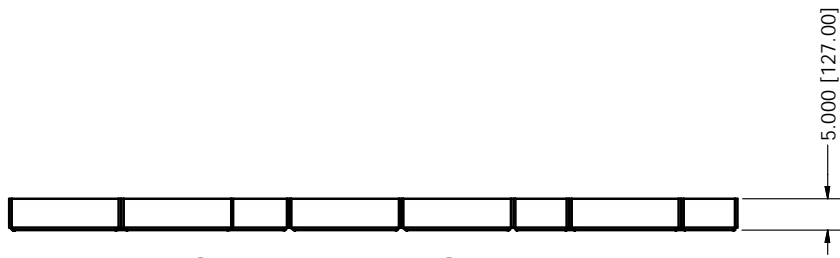

FRONT ELEVATION VIEW



SIDE ELEVATION VIEW

PRODUCT COUNTS:  
(14) TOTAL WALL UNITS

NOTE:  
1. WALL UNITS TO BE INSTALLED WITH CHANNEL ON THE BOTTOM SIDE  
(PRODUCT IS TO BE INVERTED 180 DEGREES FROM FINISHED PALLET).

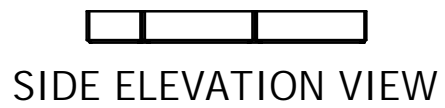
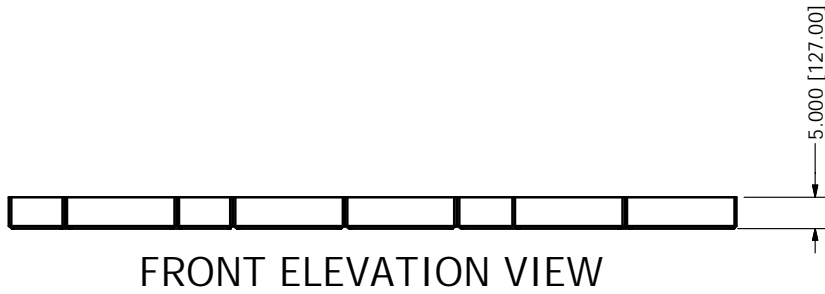
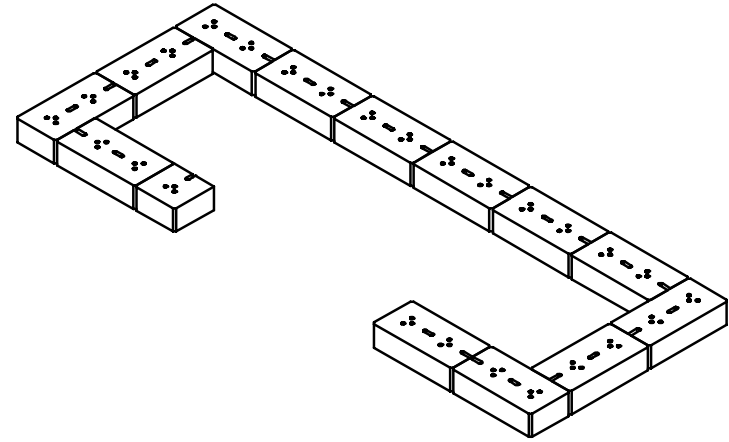
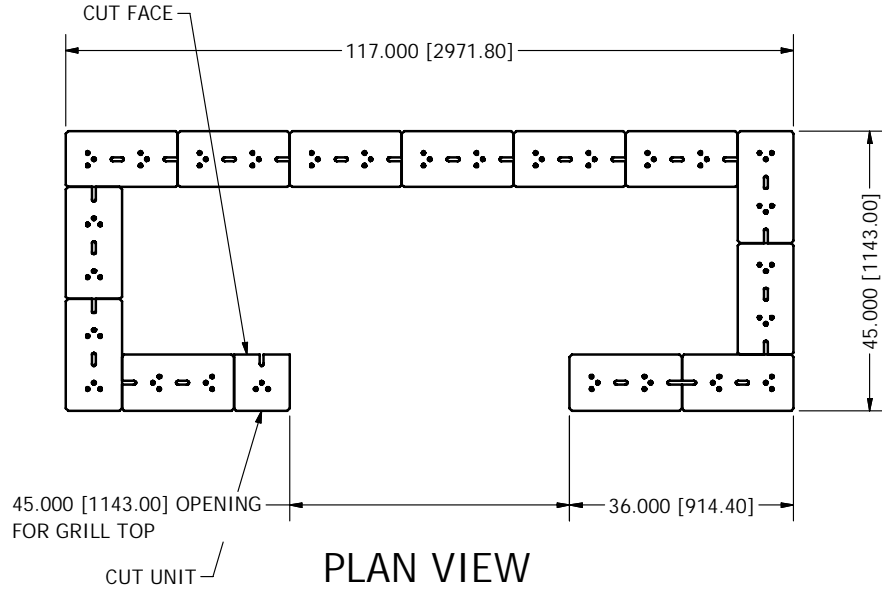

PRODUCT COUNTS:  
(14) TOTAL WALL UNITS

NOTE:  
1. WALL UNITS TO BE INSTALLED WITH CHANNEL ON THE BOTTOM SIDE  
(PRODUCT IS TO BE INVERTED 180 DEGREES FROM FINISHED PALLET).

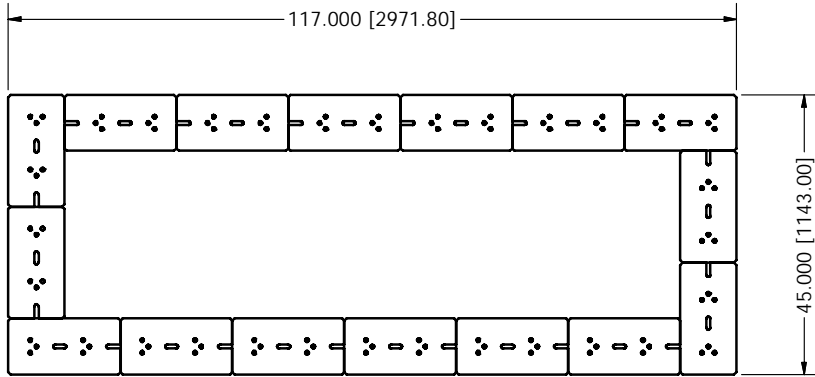

PLAN VIEW

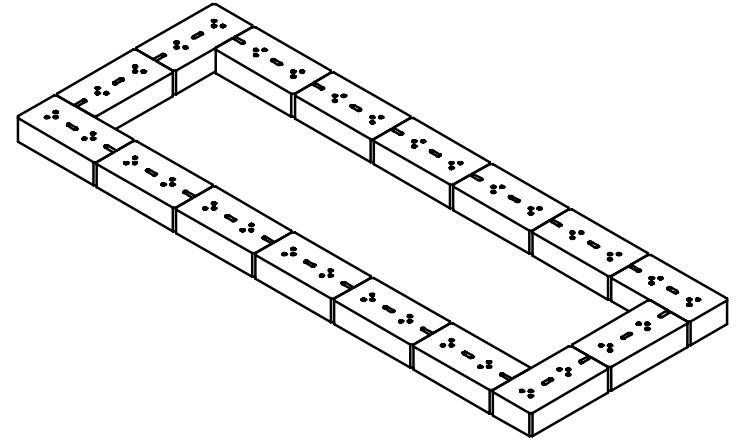

ISOMETRIC VIEW

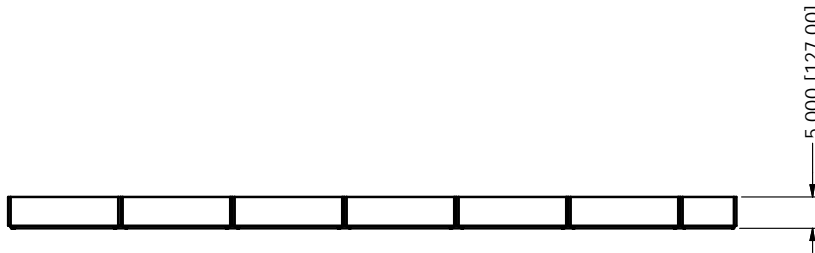

FRONT ELEVATION VIEW



SIDE ELEVATION VIEW

PRODUCT COUNTS:  
(16) TOTAL WALL UNITS

NOTE:  
1. WALL UNITS TO BE INSTALLED WITH CHANNEL ON THE BOTTOM SIDE  
(PRODUCT IS TO BE INVERTED 180 DEGREES FROM FINISHED PALLET).

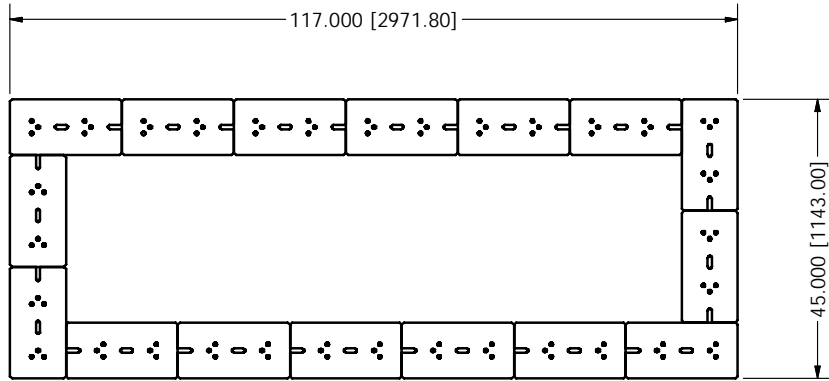

PLAN VIEW

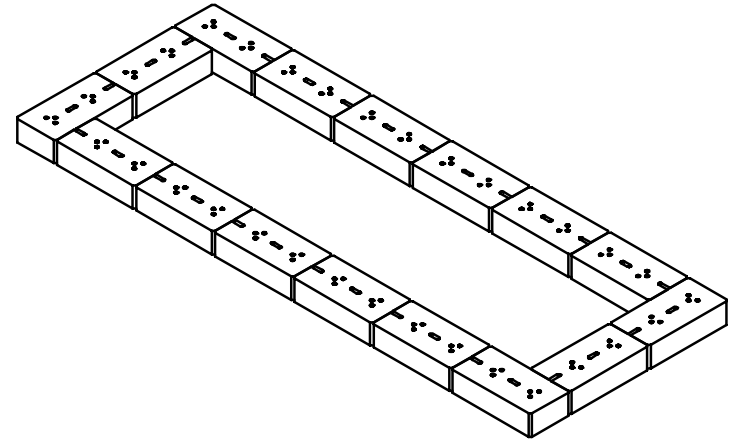

ISOMETRIC VIEW

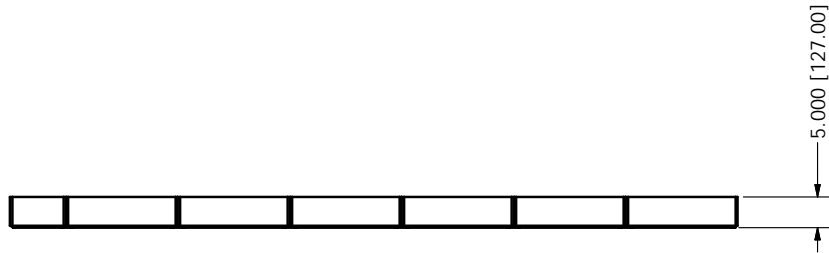

FRONT ELEVATION VIEW

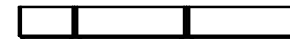

SIDE ELEVATION VIEW

PRODUCT COUNTS:  
(16) TOTAL WALL UNITS

NOTE:  
1. UNLESS OTHERWISE DIRECTED INSTALL AND SECURE COUNTERTOP WITH APPROVED ADHESIVE OR BONDING AGENT.

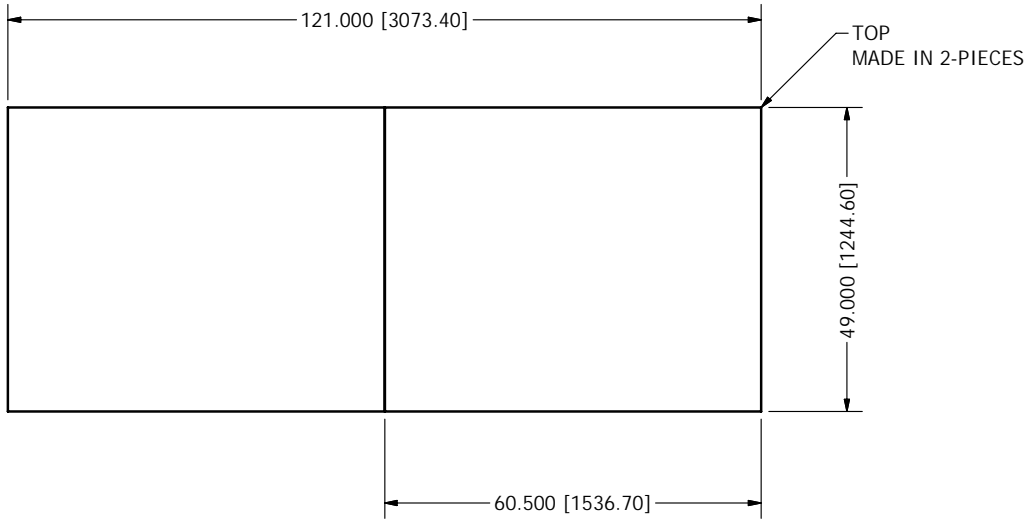

PLAN VIEW

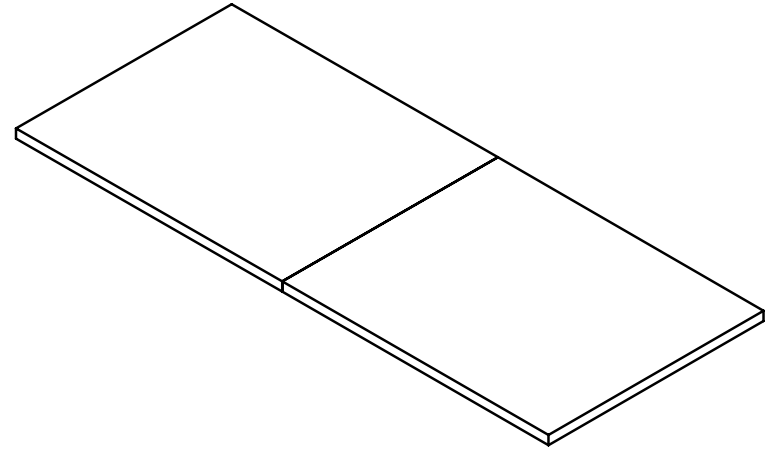

ISOMETRIC VIEW

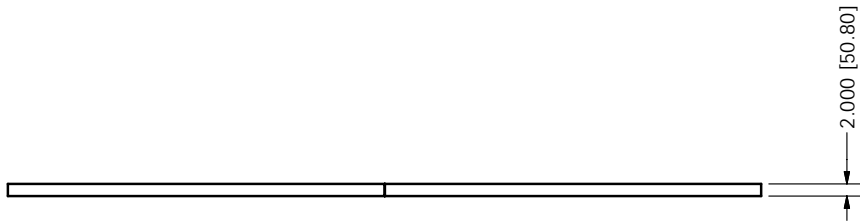

FRONT ELEVATION VIEW

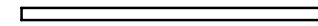

SIDE ELEVATION VIEW