

OUTDOOR LIVING DESIGNS

NOTE:

1. WALL UNITS TO BE INSTALLED WITH CHANNEL ON THE BOTTOM SIDE IN ORDER TO GET THE PROPER CONTEMPORARY ESTHETIC LOOK. (WALL PRODUCT TO BE INVERTED 180 DEGREES FROM FINISHED PALLET WHEN INSTALLED).
2. SECURE EACH UNIT USING APPROVED ADHESIVE OR BONDING AGENT FOLLOWING APPLICATION DIRECTIONS PROVIDED BY PRODUCT SUPPLIER.
3. THIS DESIGN REQUIRES CUTTING UNITS TO PROPERLY FIT THE GRILL TOP AND ACCESS DOOR.
4. BUILT-IN GRILL INSERT AND ACCESS DOOR TO BE INSTALLED PER MANUFACTURES RECOMMENDATIONS.
5. STRUCTURAL SUPPORT FOR BLOCK UNITS OVER OPENINGS ON SHOWN FOR VISUAL PURPOSES.

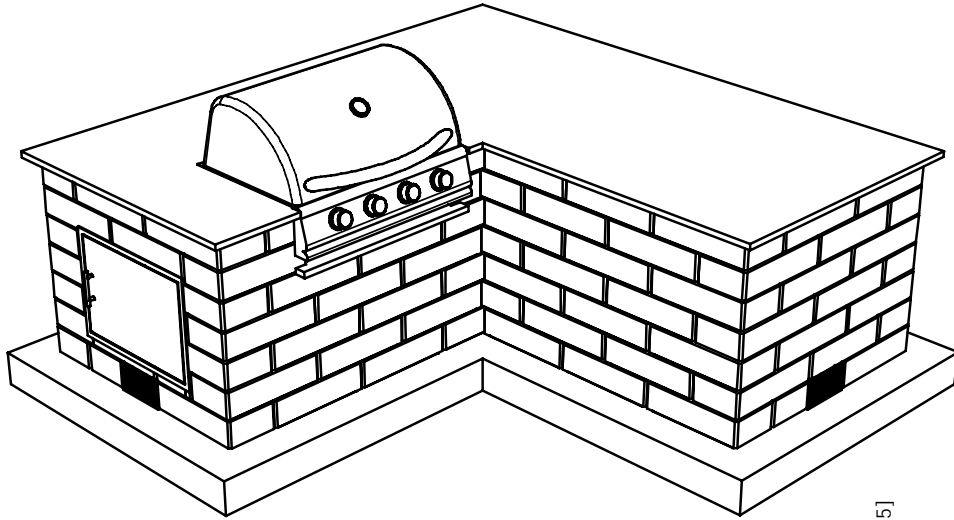

ISOMETRIC VIEW

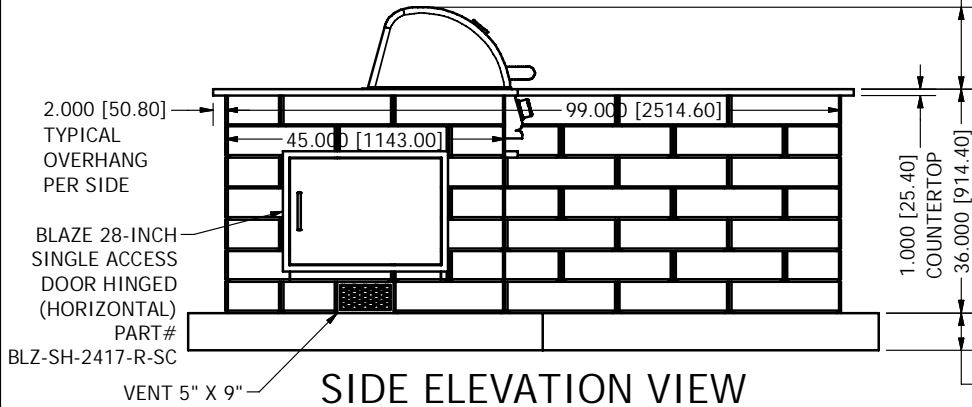

SIDE ELEVATION VIEW

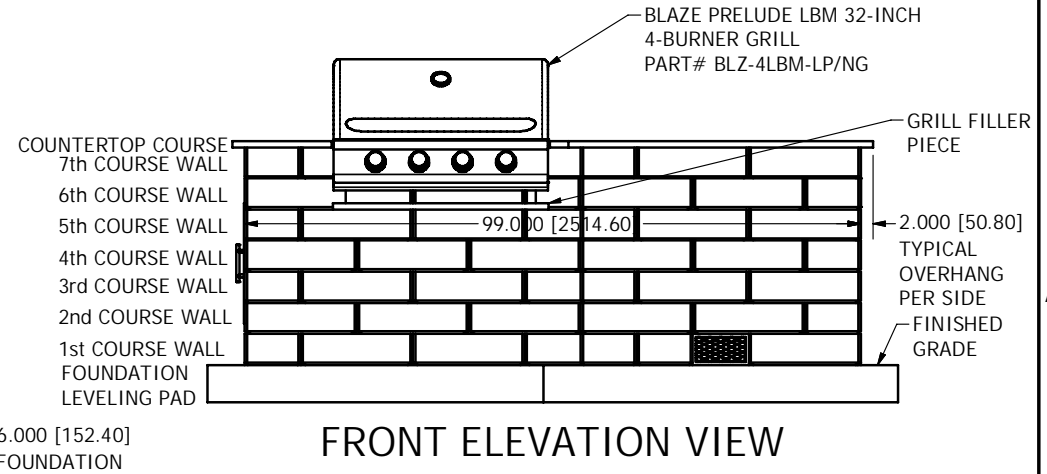

FRONT ELEVATION VIEW

PRODUCT COUNTS:
(140) TOTAL WALL UNITS

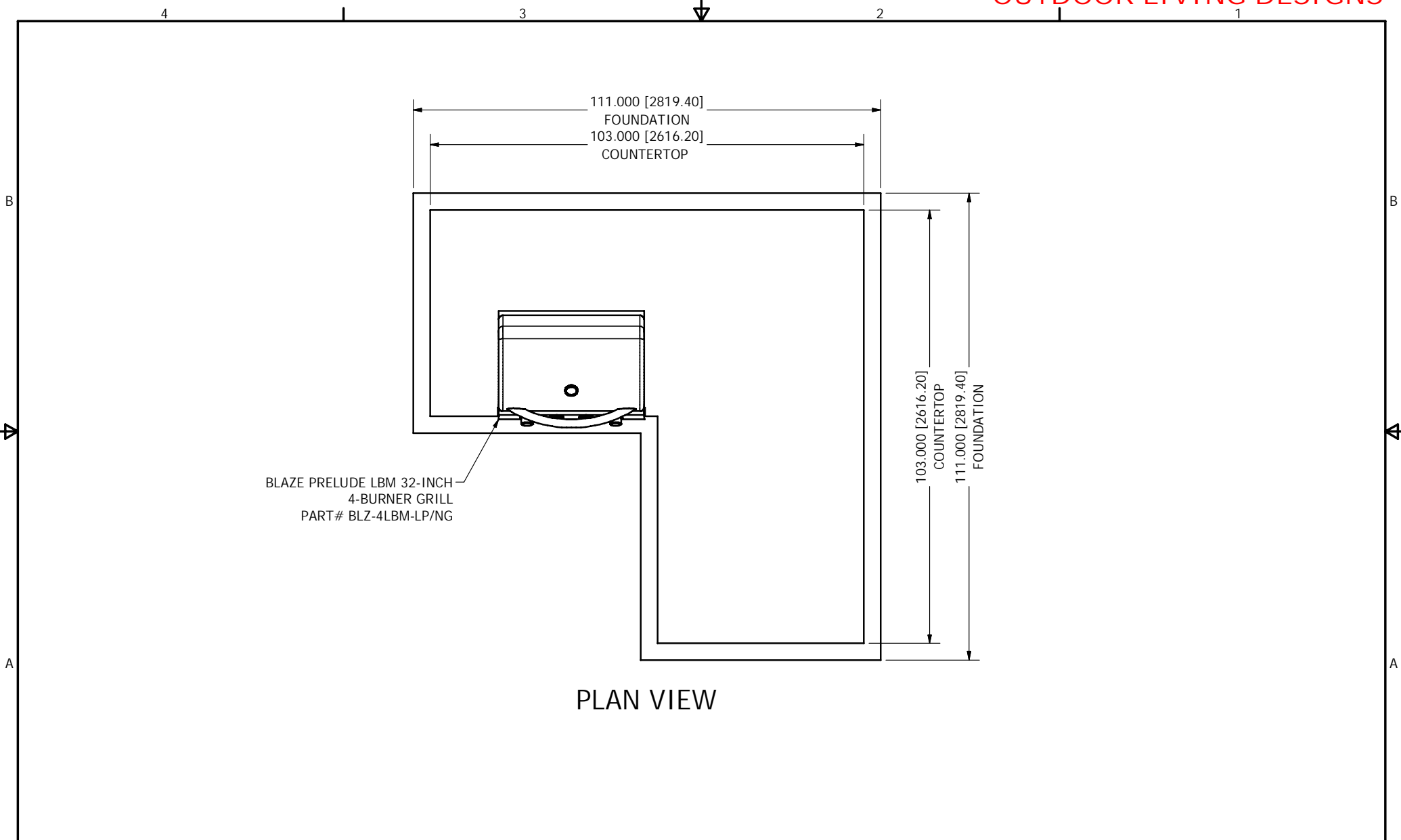

PLAN VIEW

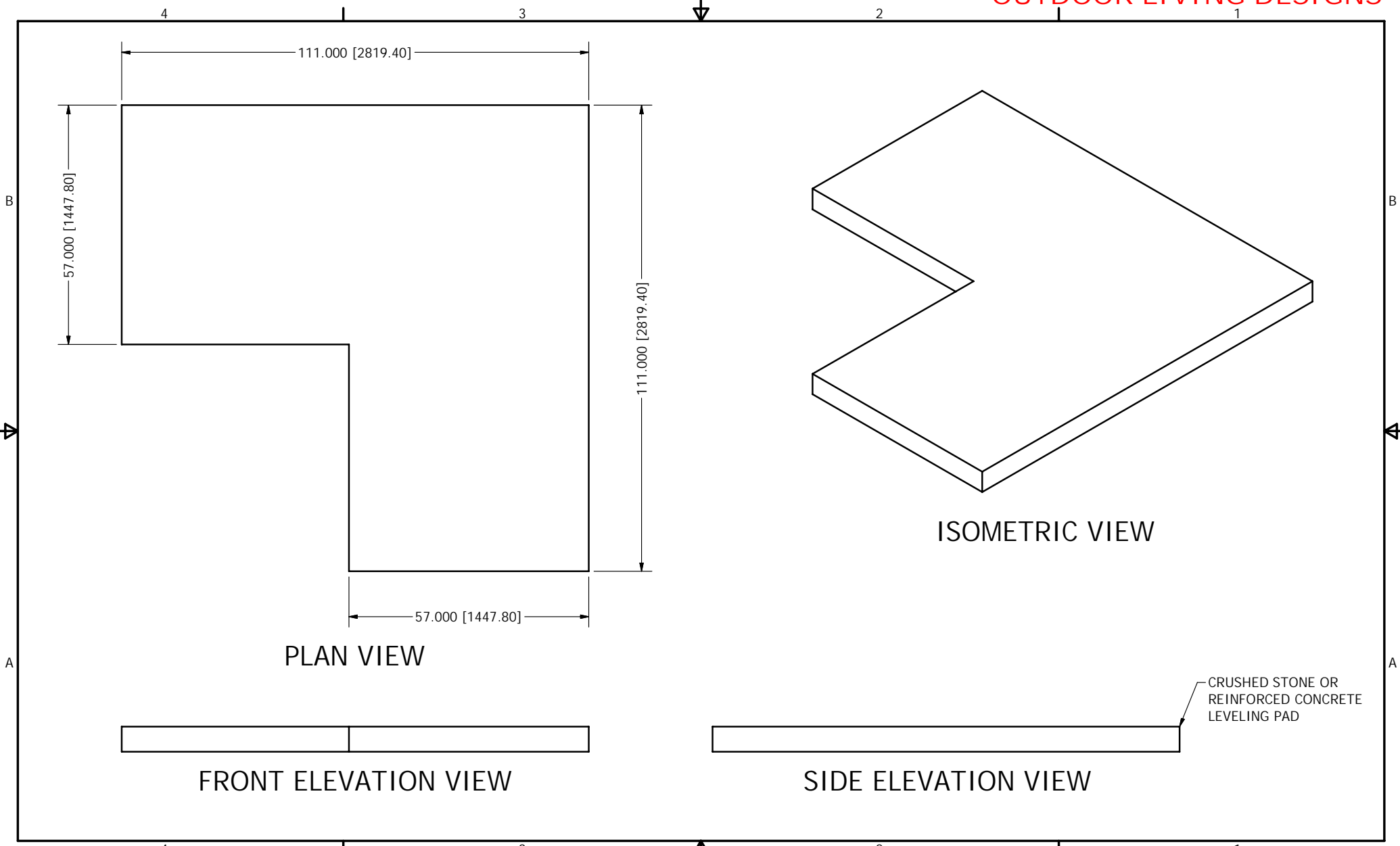

PLAN VIEW

FRONT ELEVATION VIEW

ISOMETRIC VIEW

SIDE ELEVATION VIEW

CRUSHED STONE OR
REINFORCED CONCRETE
LEVELING PAD

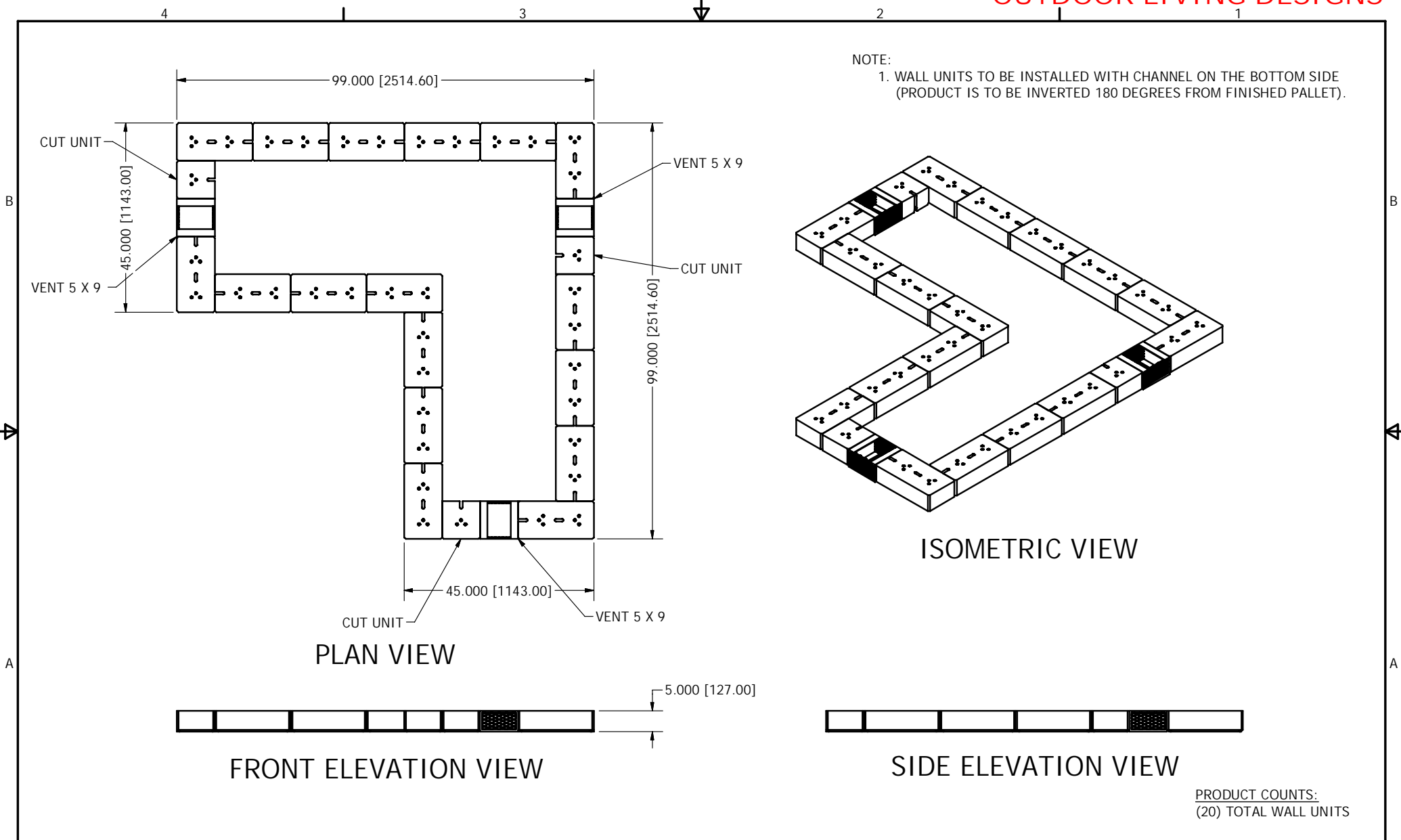

NOTE:
1. WALL UNITS TO BE INSTALLED WITH CHANNEL ON THE BOTTOM SIDE
(PRODUCT IS TO BE INVERTED 180 DEGREES FROM FINISHED PALLET).

ISOMETRIC VIEW

PLAN VIEW

FRONT ELEVATION VIEW

SIDE ELEVATION VIEW

PRODUCT COUNTS:
(20) TOTAL WALL UNITS

NOTE:
1. WALL UNITS TO BE INSTALLED WITH CHANNEL ON THE BOTTOM SIDE
(PRODUCT IS TO BE INVERTED 180 DEGREES FROM FINISHED PALLET).

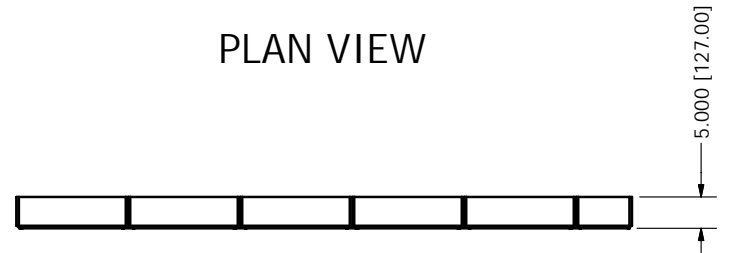
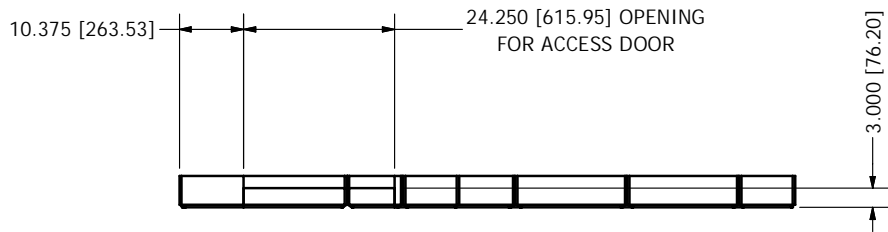
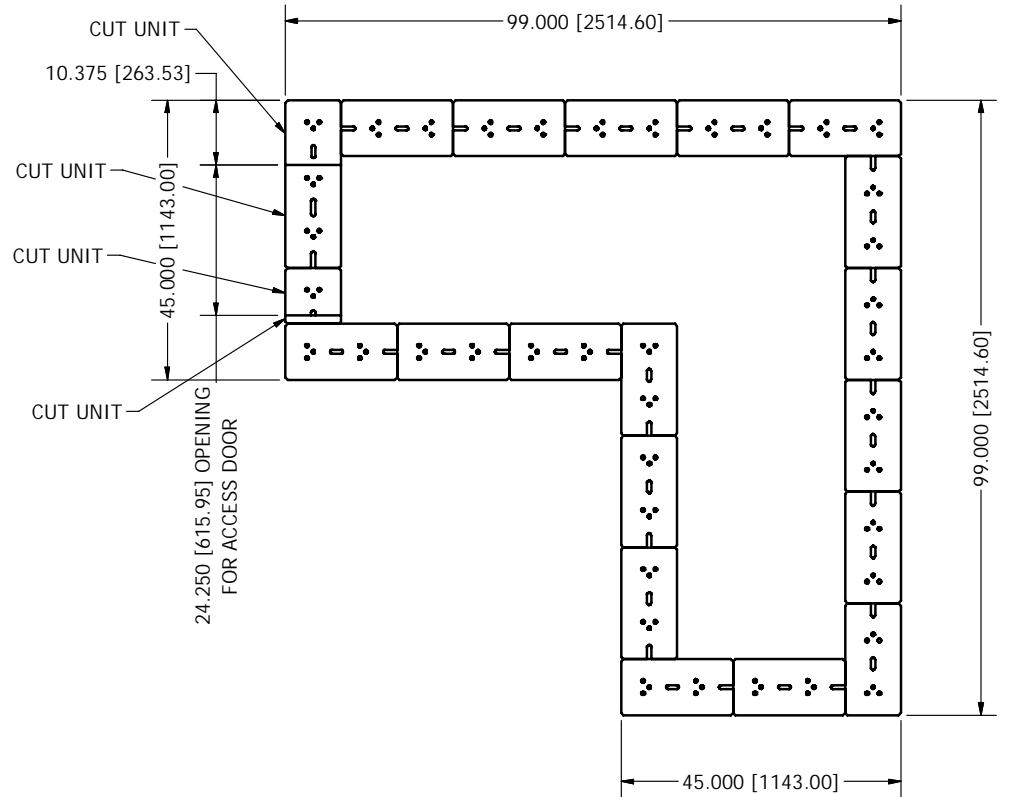
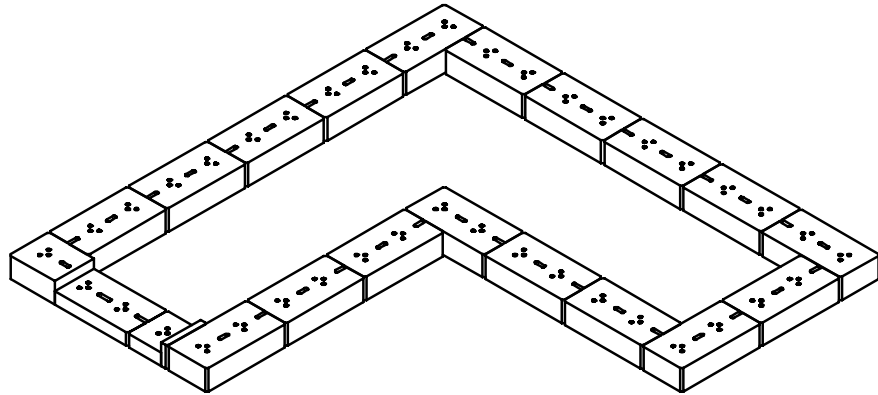

PRODUCT COUNTS:
(22) TOTAL WALL UNITS

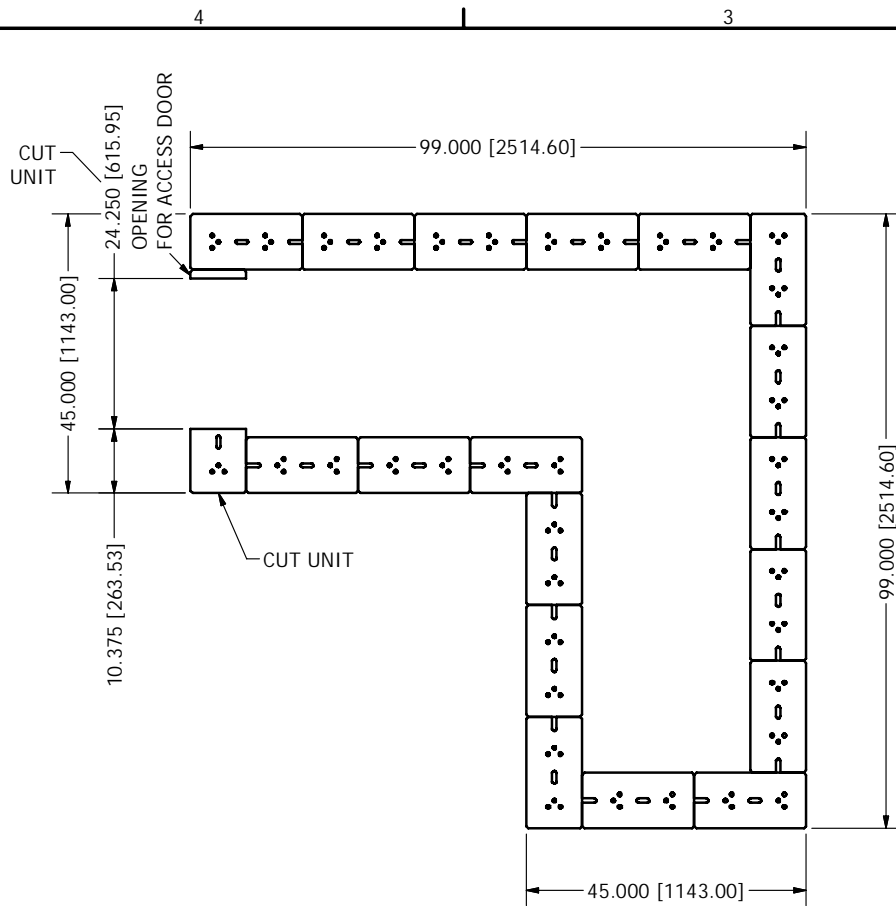

PLAN VIEW

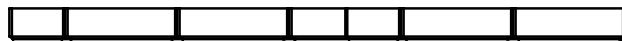

FRONT ELEVATION VIEW

NOTE:

1. WALL UNITS TO BE INSTALLED WITH CHANNEL ON THE BOTTOM SIDE (PRODUCT IS TO BE INVERTED 180 DEGREES FROM FINISHED PALLET).

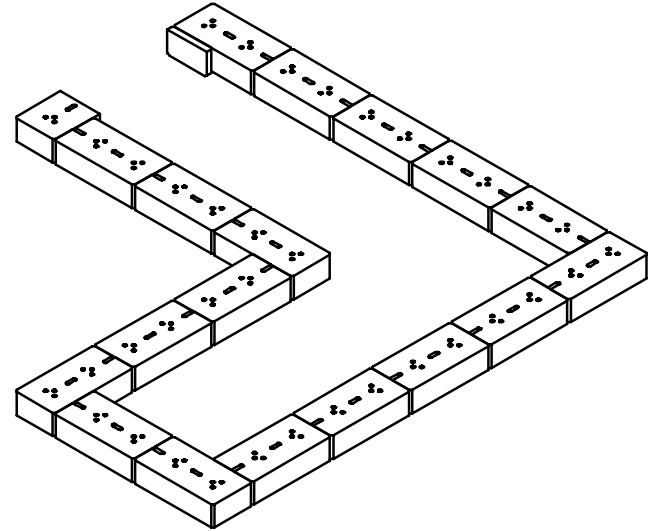

ISOMETRIC VIEW



SIDE ELEVATION VIEW

PRODUCT COUNTS:
(20) TOTAL CAP UNITS

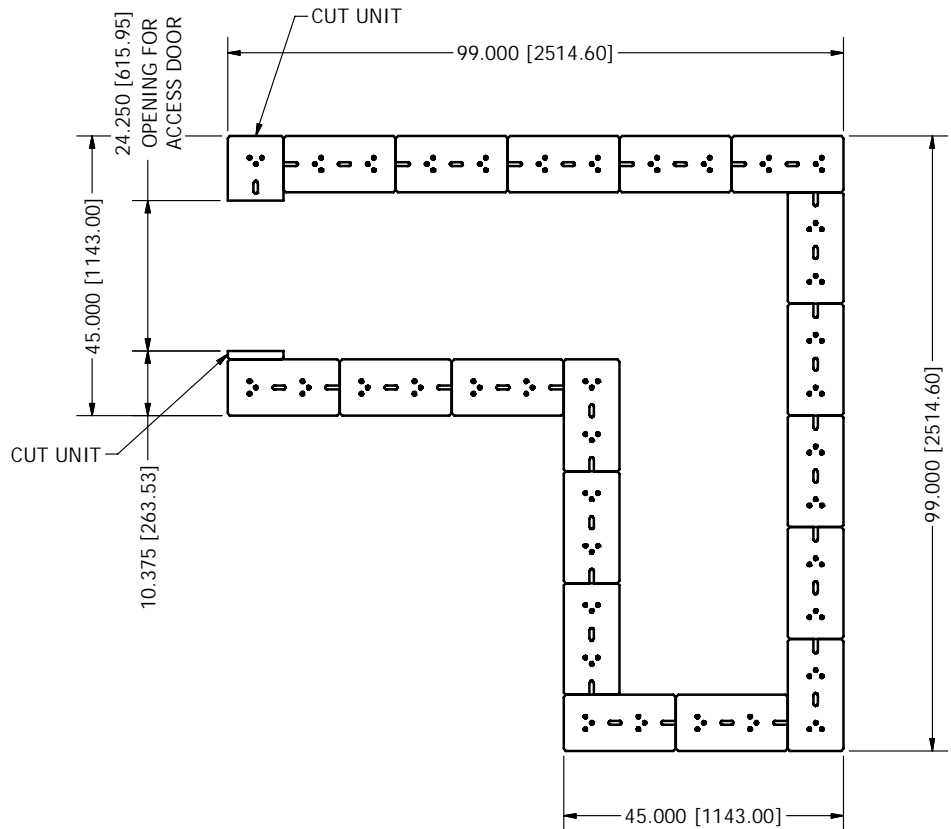

PLAN VIEW



FRONT ELEVATION VIEW

NOTE:
1. WALL UNITS TO BE INSTALLED WITH CHANNEL ON THE BOTTOM SIDE (PRODUCT IS TO BE INVERTED 180 DEGREES FROM FINISHED PALLET).

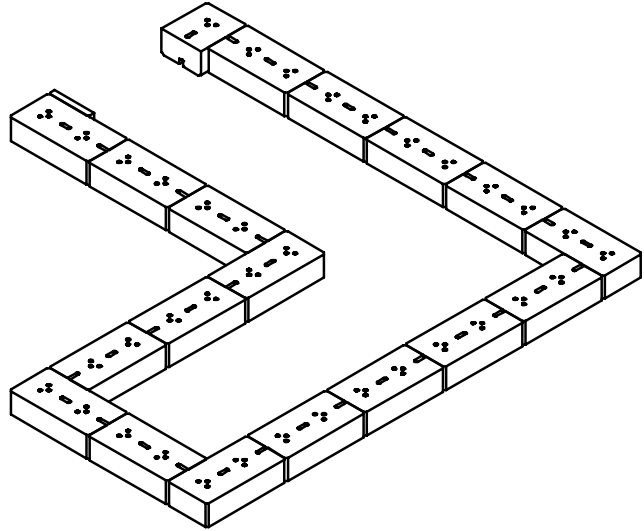

ISOMETRIC VIEW

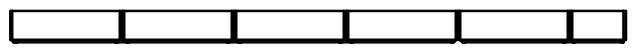

SIDE ELEVATION VIEW

PRODUCT COUNTS:
(20) TOTAL CAP UNITS

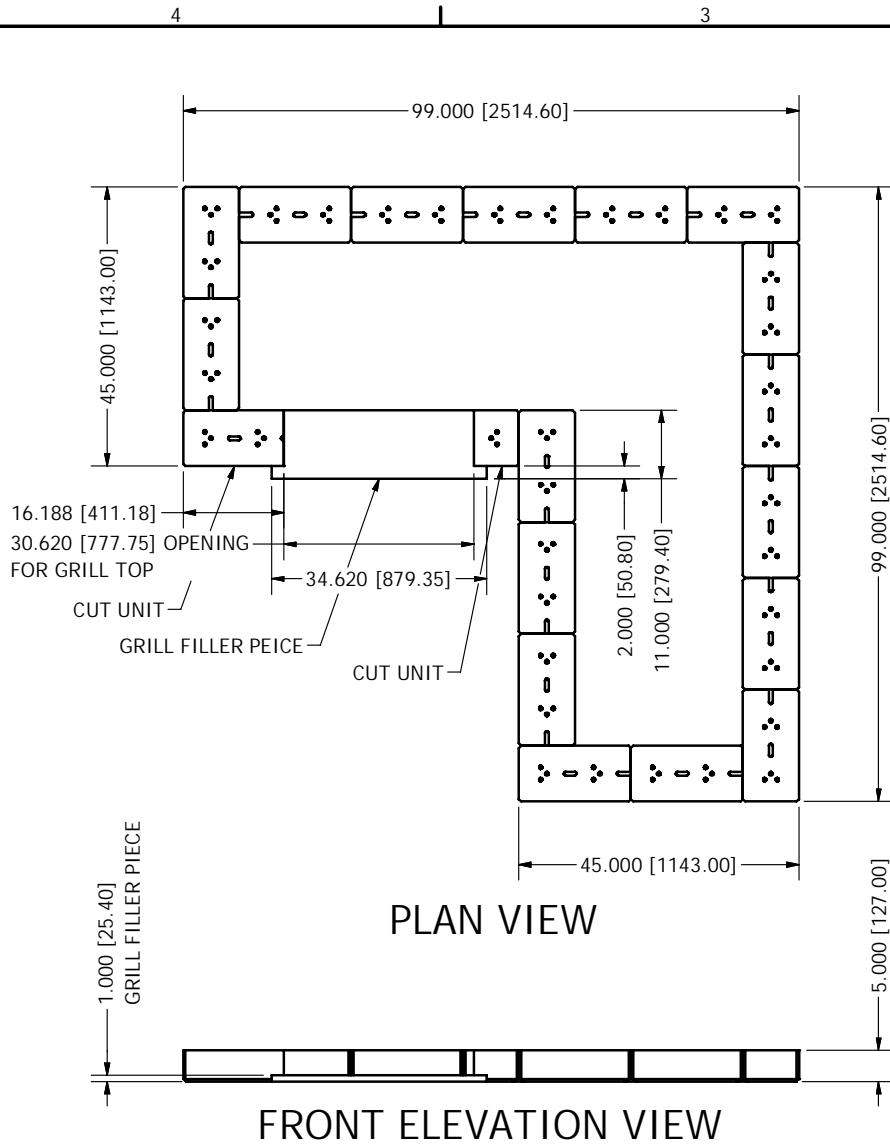

- NOTE:
1. WALL UNITS TO BE INSTALLED WITH CHANNEL ON THE BOTTOM SIDE (PRODUCT IS TO BE INVERTED 180 DEGREES FROM FINISHED PALLET).
 2. GRILL FILLER PIECE IS TO BE MADE FROM THE SAME MATERIAL AS THE COUNTER TOP, (1" ± THICK).
 3. UNLESS OTHERWISE DIRECTED INSTALL AND SECURE GRILL FILLER PIECE WITH APPROVED ADHESIVE OR BONDING AGENT.

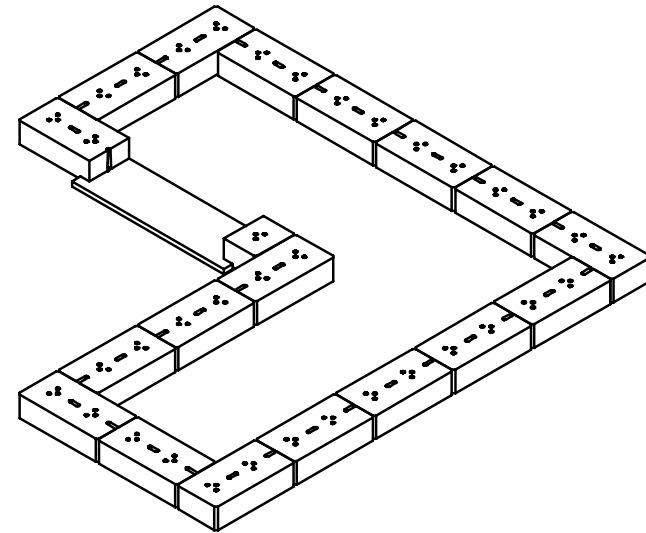

ISOMETRIC VIEW



SIDE ELEVATION VIEW

PRODUCT COUNTS:
(19) TOTAL WALL UNITS

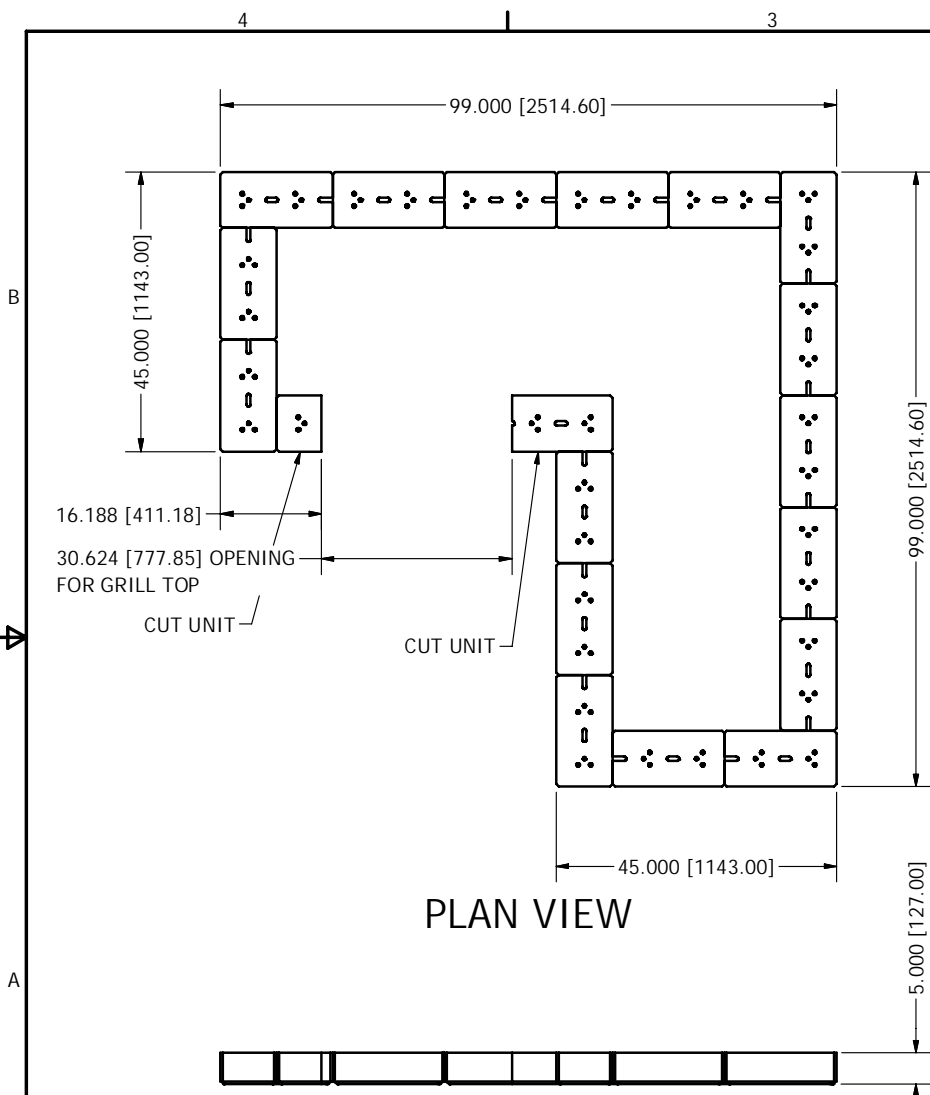

NOTE:
1. WALL UNITS TO BE INSTALLED WITH CHANNEL ON THE BOTTOM SIDE
(PRODUCT IS TO BE INVERTED 180 DEGREES FROM FINISHED PALLET).

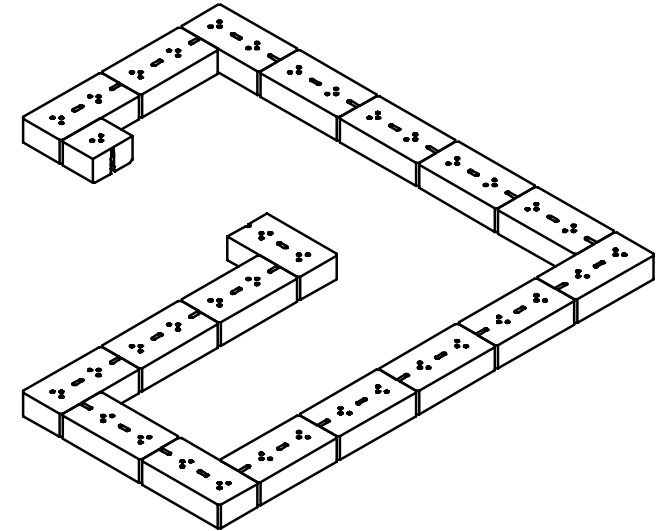

ISOMETRIC VIEW



SIDE ELEVATION VIEW

PRODUCT COUNTS:
(19) TOTAL WALL UNITS

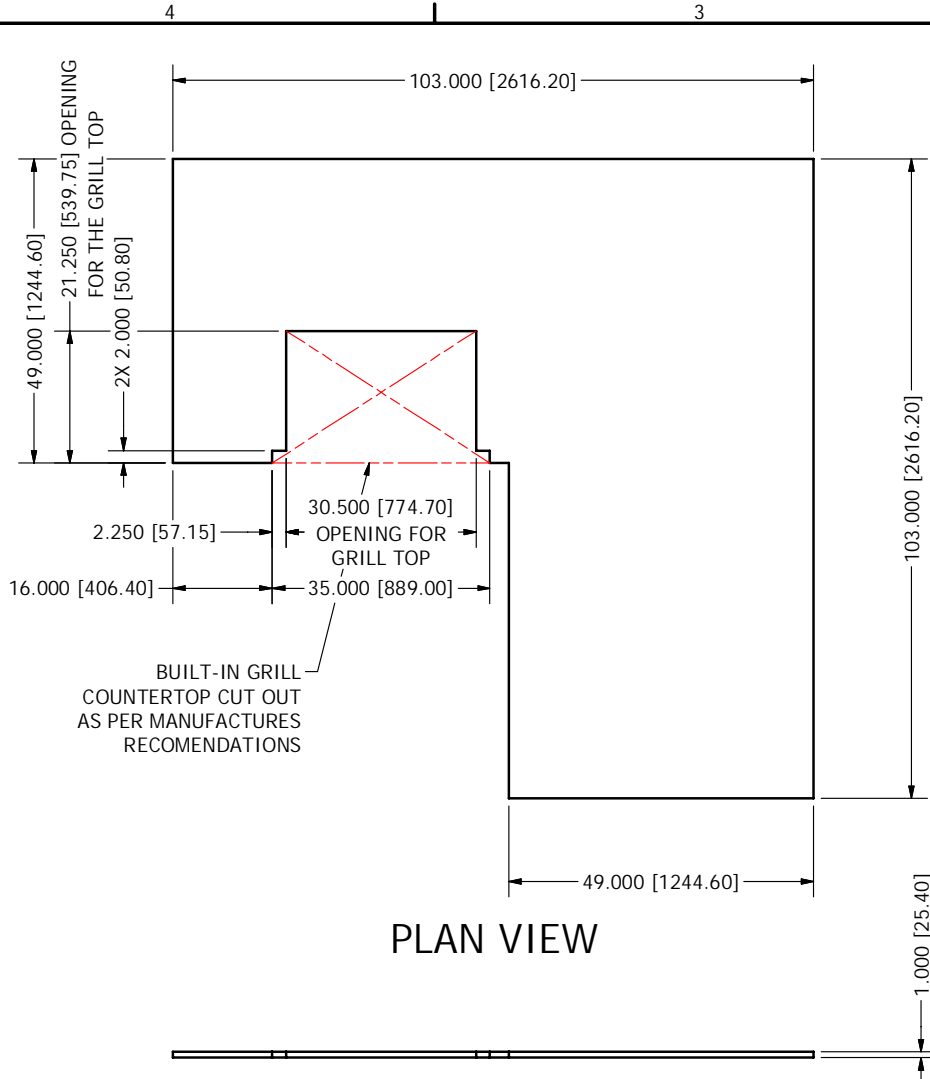

PLAN VIEW

FRONT ELEVATION VIEW

NOTE:
1. UNLESS OTHERWISE DIRECTED INSTALL AND SECURE COUNTERTOP WITH APPROVED ADHESIVE OR BONDING AGENT.

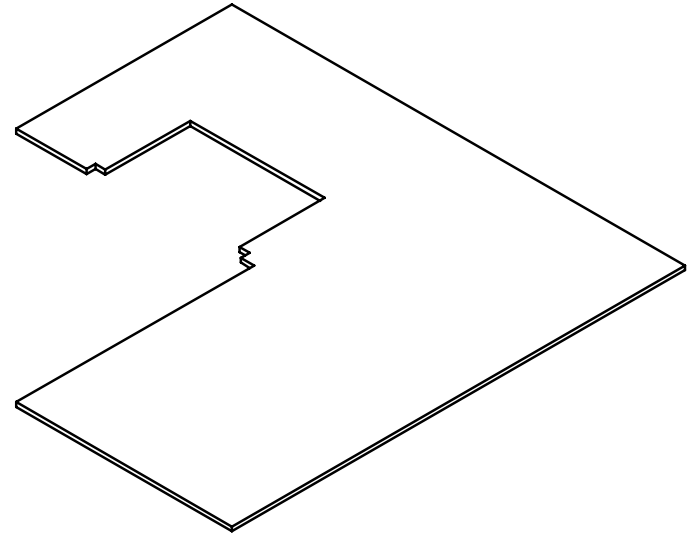

ISOMETRIC VIEW



SIDE ELEVATION VIEW